

1 2 3 4 5 6 7 8 9 10

A  
B  
C  
D  
E  
F  
G

A  
B  
C  
D  
E  
F  
G

■ SPECIFICATIONS

- Voltage Rating: 250V AC/DC
- Current Rating: 2.5A AC/DC
- Withstanding Voltage: 800V AC/minute
- Insulation Resistance: 1,000MΩmin
- Temperature Range: -25° C to +85° C
- Contact Resistance: 20mΩmax

TERMINAL

- Part No: SCT2517TRPC
- Wire Range: AWG#22-#28
- Material: Brass
- Finish: Tin Plated
- Thickness: 0.20mm
- Q`TY: 10,000PCS/roll

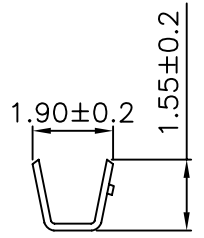
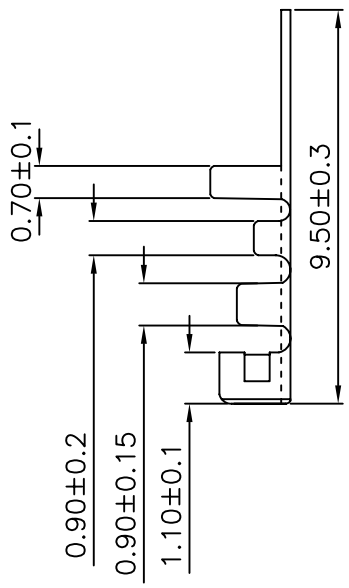
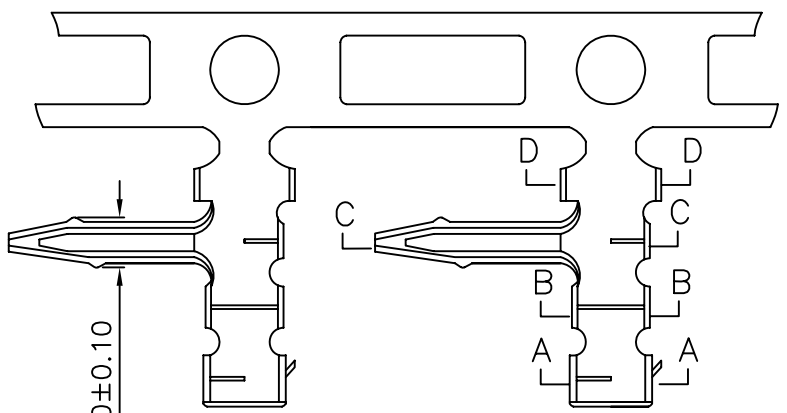

A-A

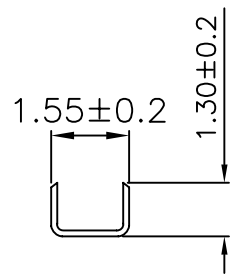

B-B

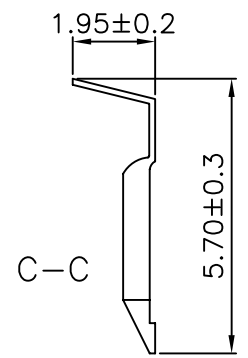

C-C

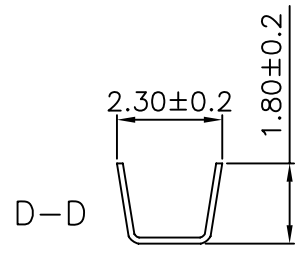

D-D

						OPERATION	DRAW			SCALE		 森康达电子有限公司 SCONDAR ELECTRONIC LIMITED	
						~ 10 ±0.15	DESIGN			UNIT	mm		
						20 ~ 30 ±0.30	CHECK			SIZE	A4	PART NO.	SCT2517TRPC
						30 ~ ±0.50	APPROVE			SHEET	1/1	TITLE:	SCN2.5 90C TERMINAL
0	05/12/27		NEW			Angle ± 2'				PROJ.	◆	DRAWING NO.	SCT2517
REV	DATE		MODIFICATION DESCRIPTION	CHANGE	APPROVE	DIM TOL							

1 2 3 4 5 6 7 8 9 10